



# **SISTEMA 3P 43**

**PROFILI ( scala 1 : 1 )**

**3P**  
ALUMINUM



3P 43

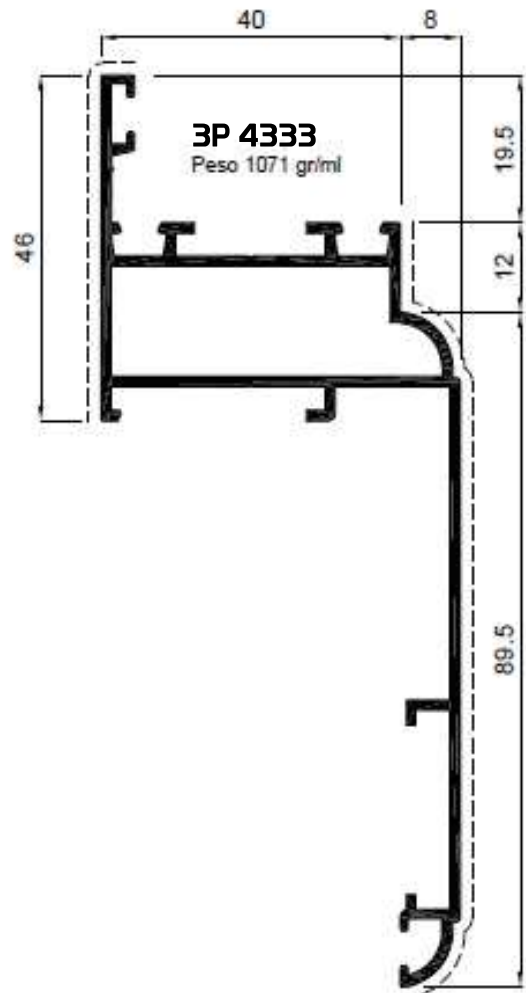
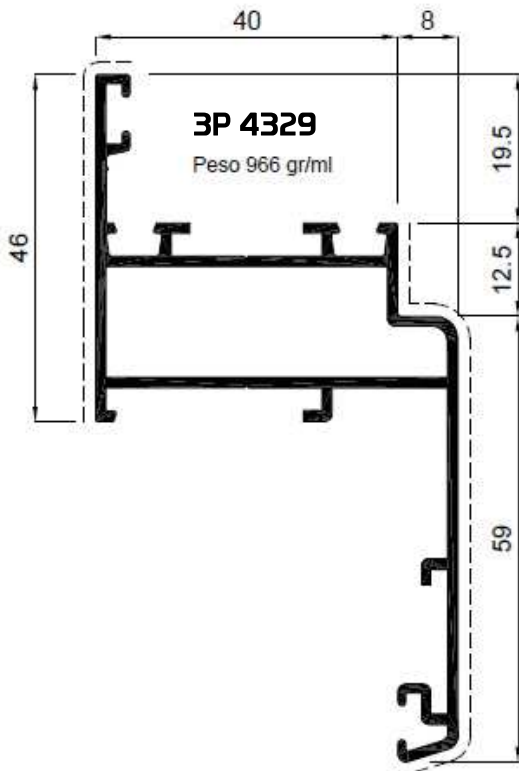
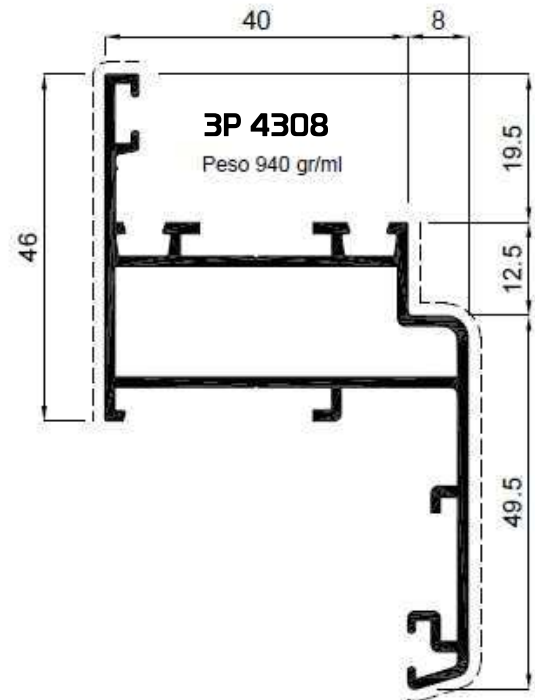
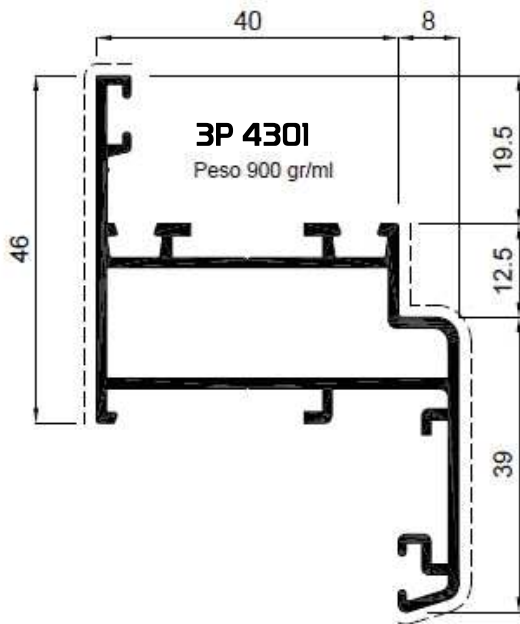

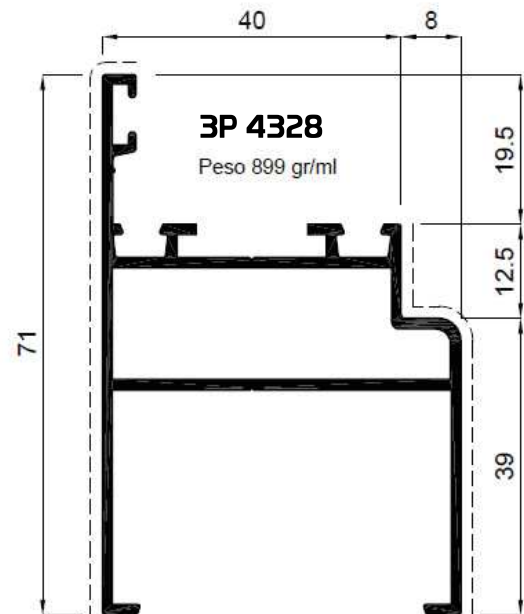
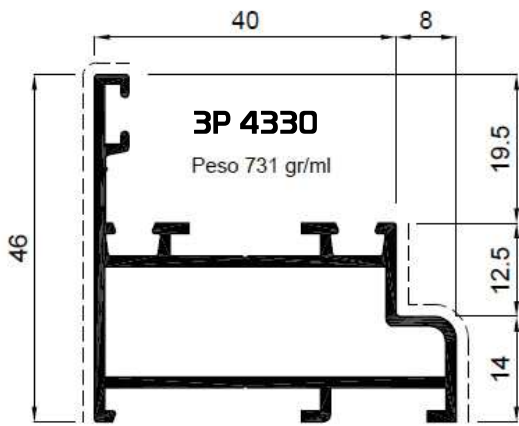
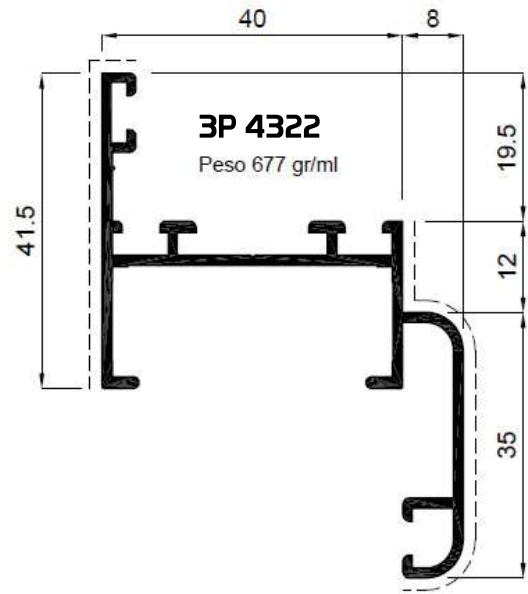
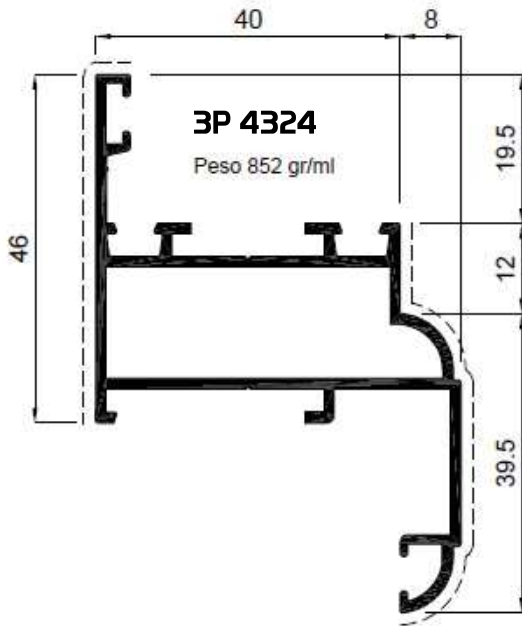



3P 43

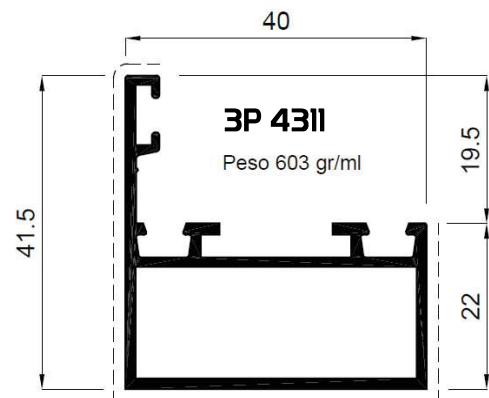
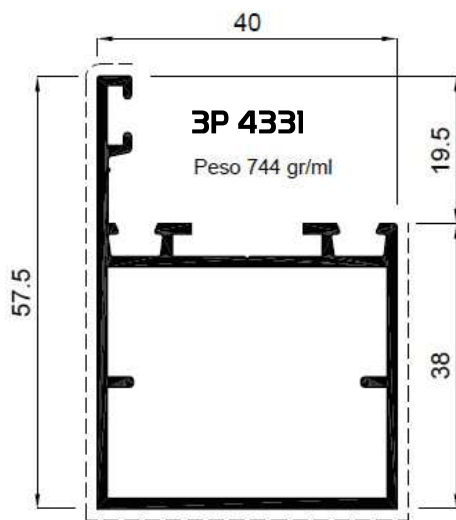
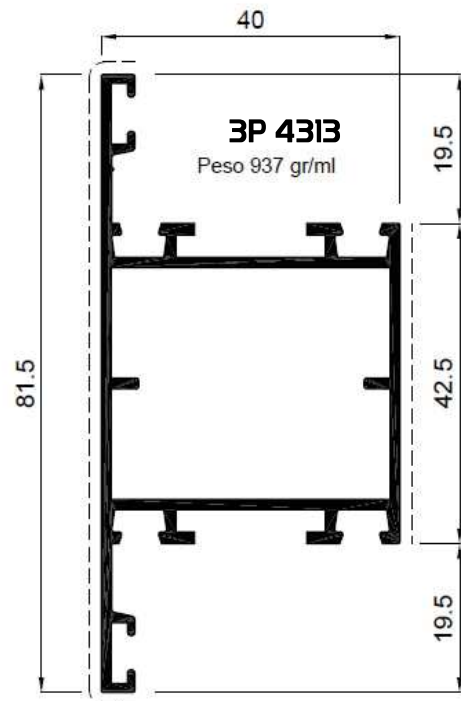
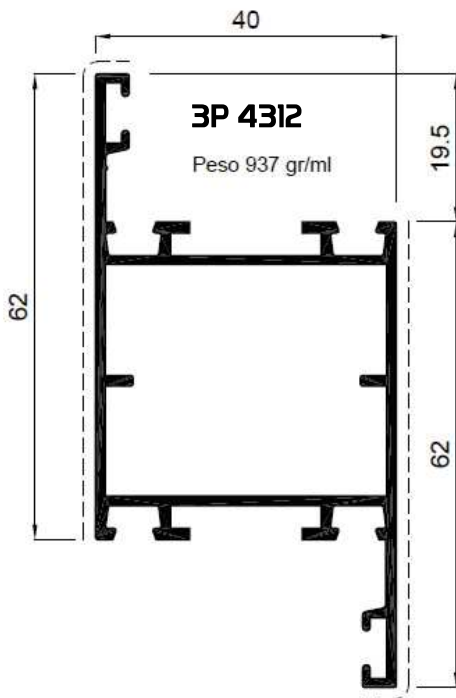

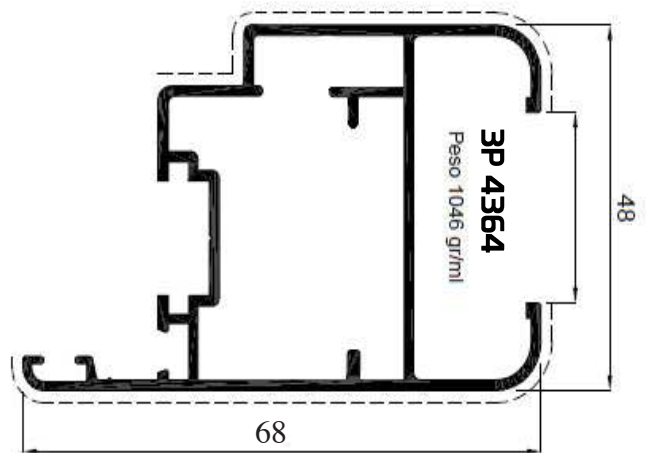
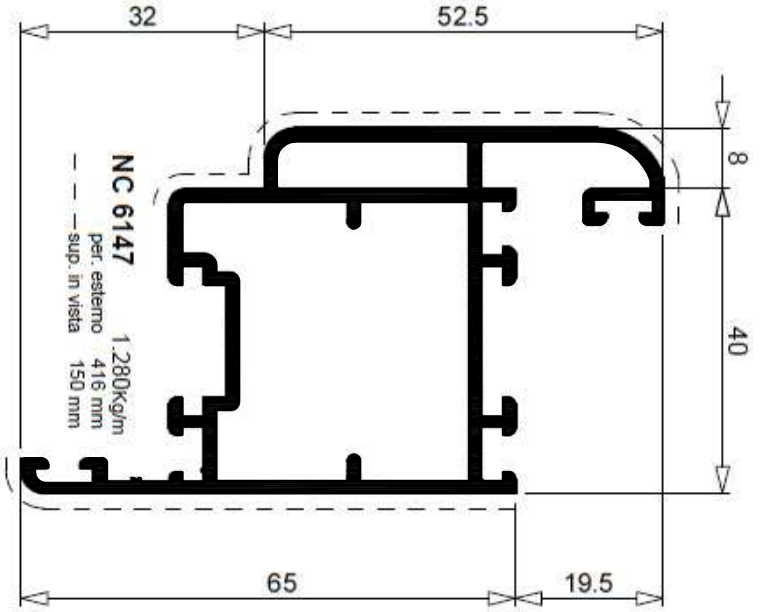
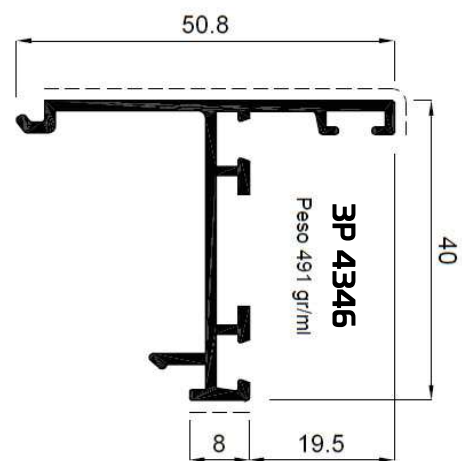
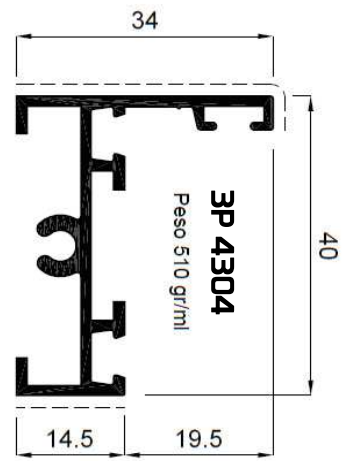
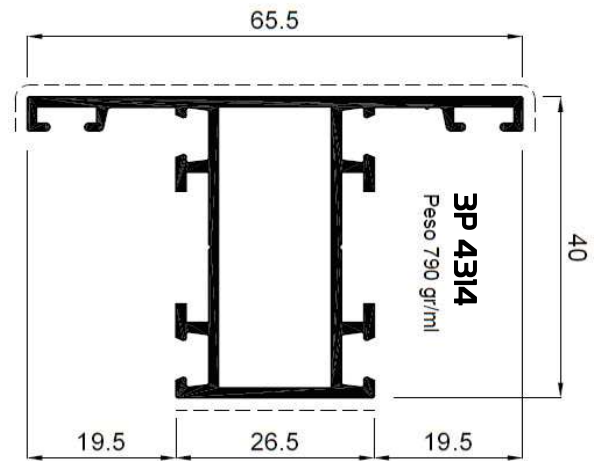
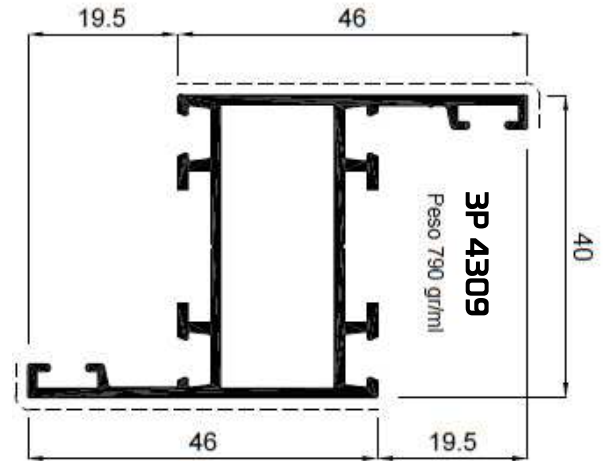

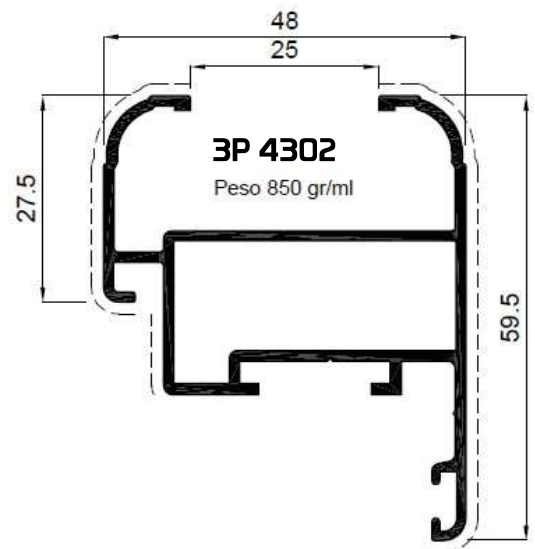
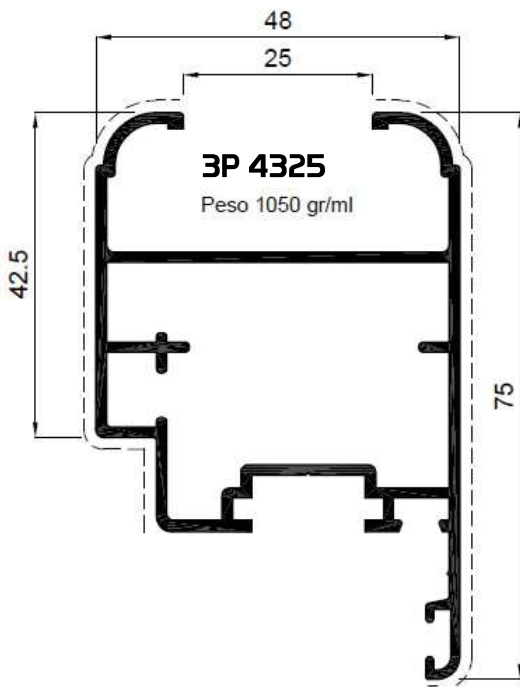
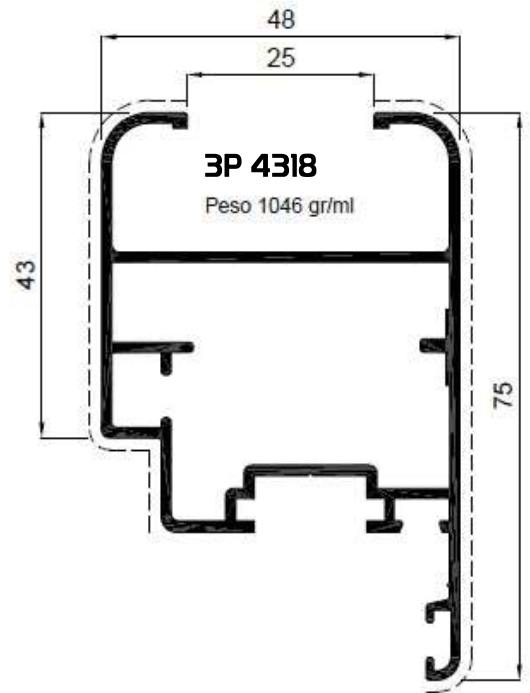
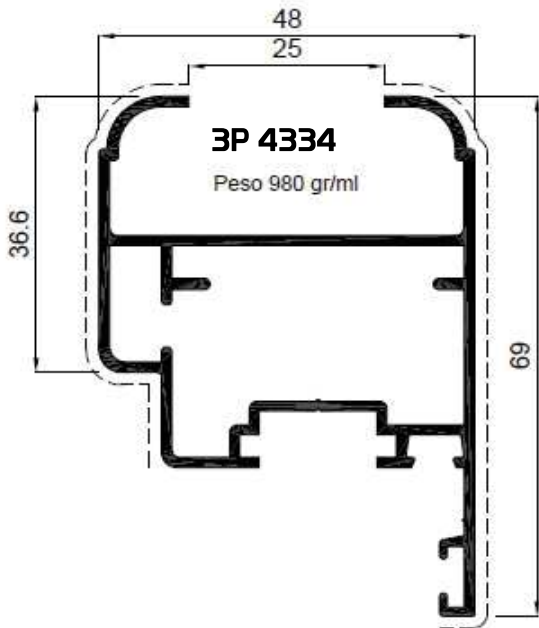

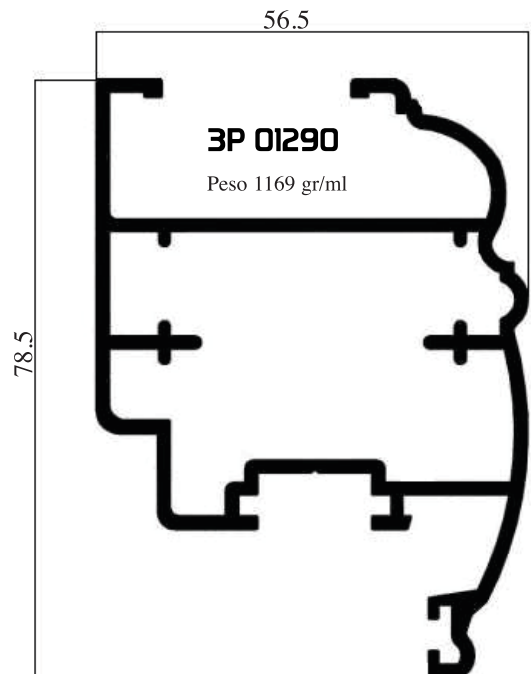
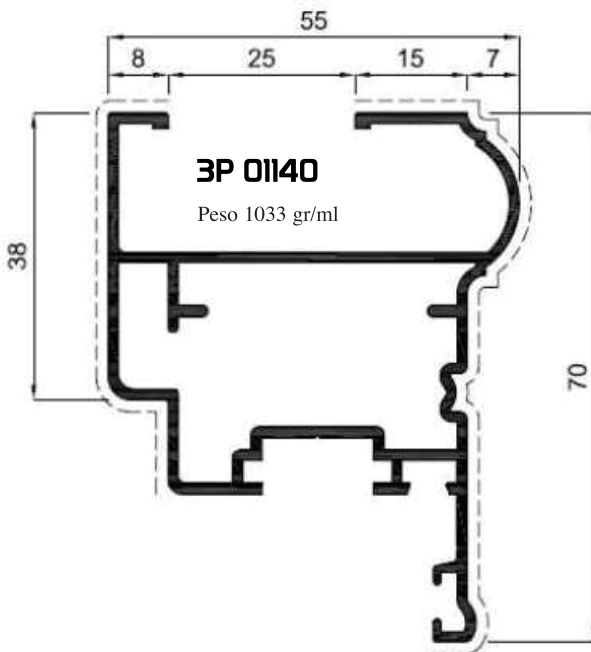
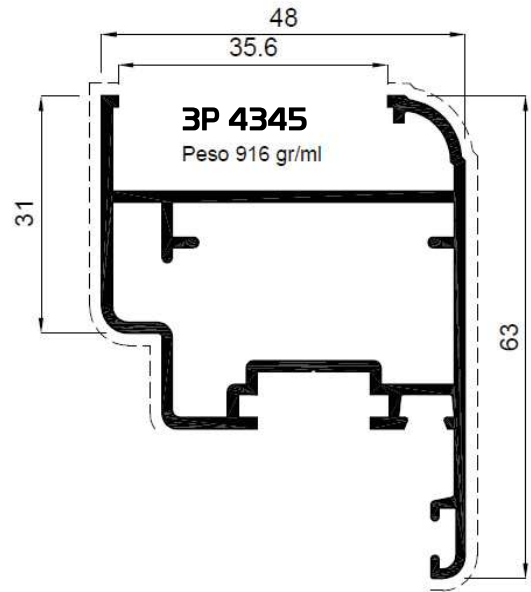
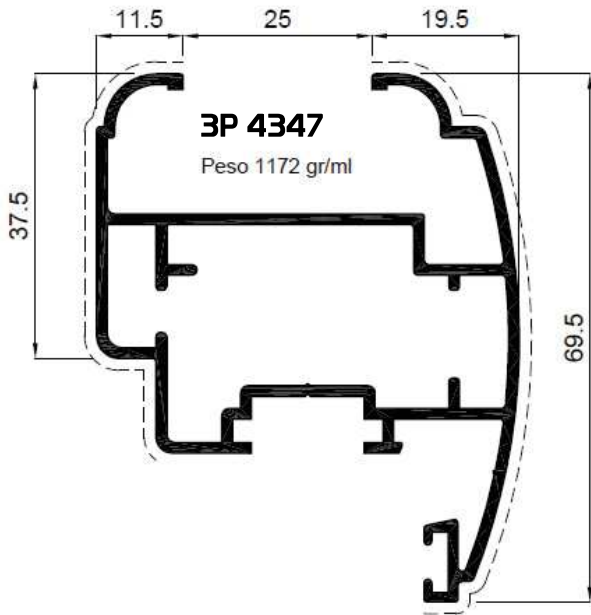



3P 43

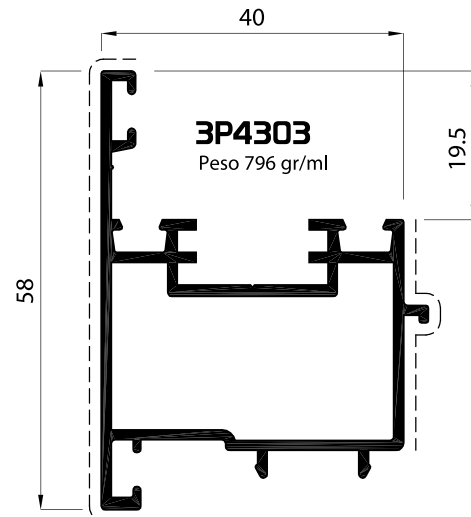
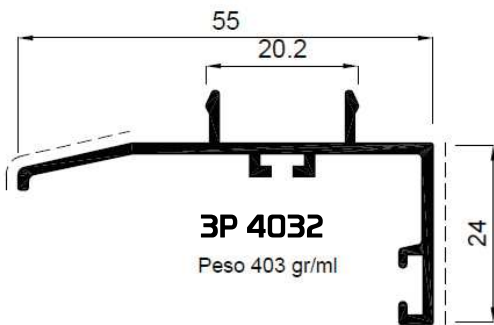
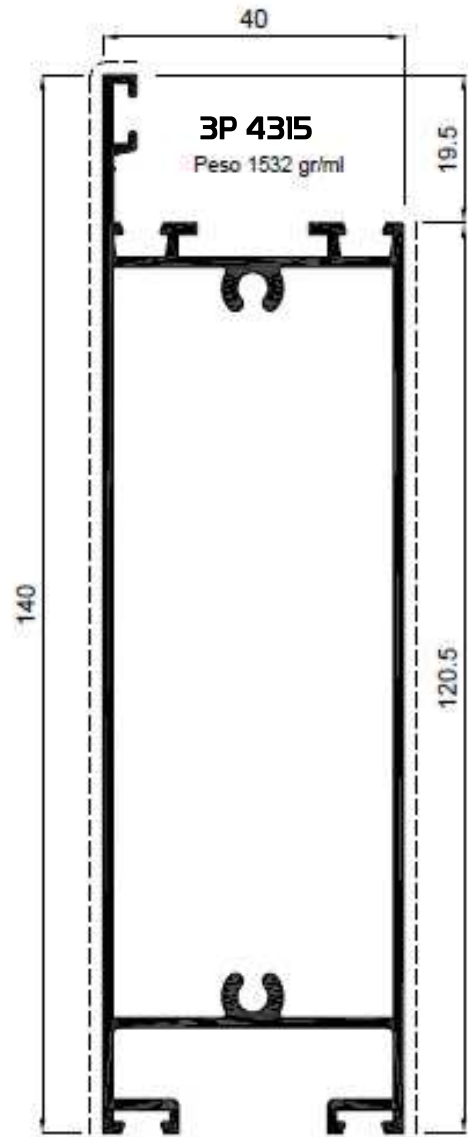
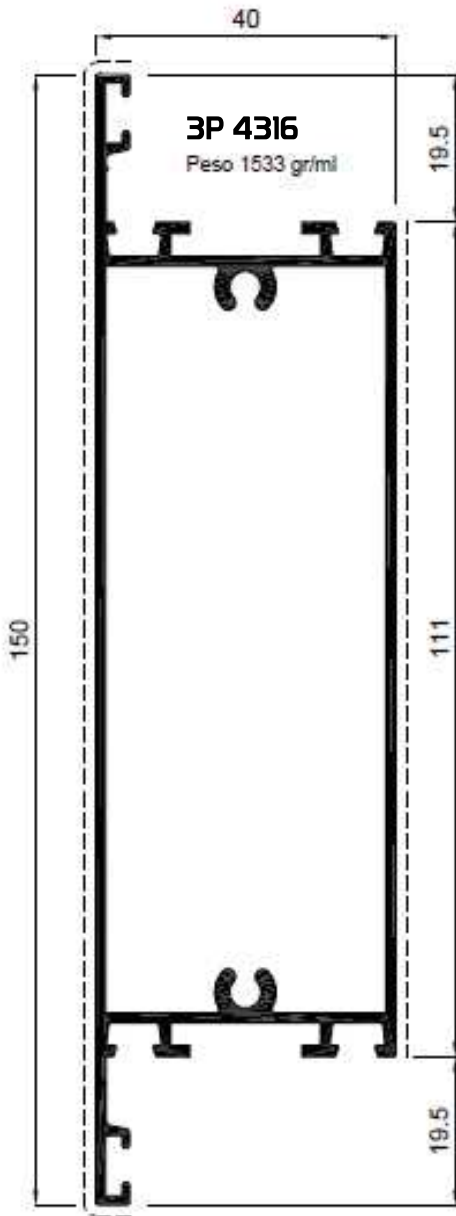



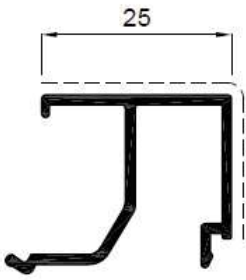

**3P 4039**

Peso 297 gr/ml

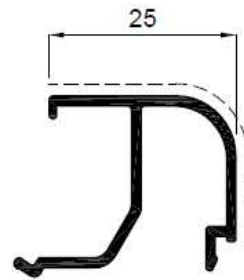

**3P 4041**

Peso 288 gr/ml

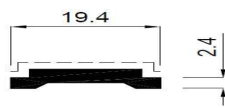

**3P 4022**  
**NC 1459**  
**6405**

Peso 164 gr/ml

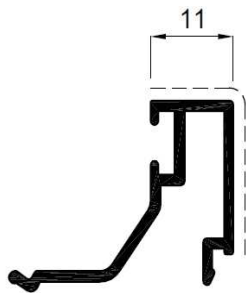

**3P 4040**

Peso 268 gr/ml

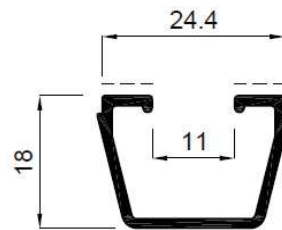

**3P 4023**

Peso 235 gr/ml

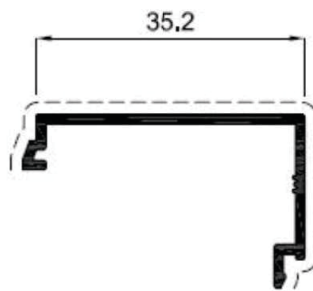

**3P 4361**

Peso 237 gr/ml

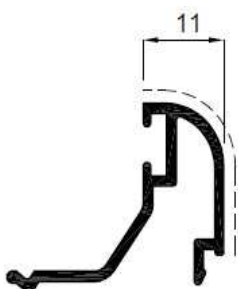

**3P 4042**

Peso 259 gr/ml

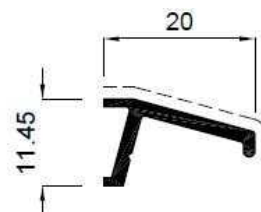

**3P 20013**

Peso 142 gr/ml



3P 43

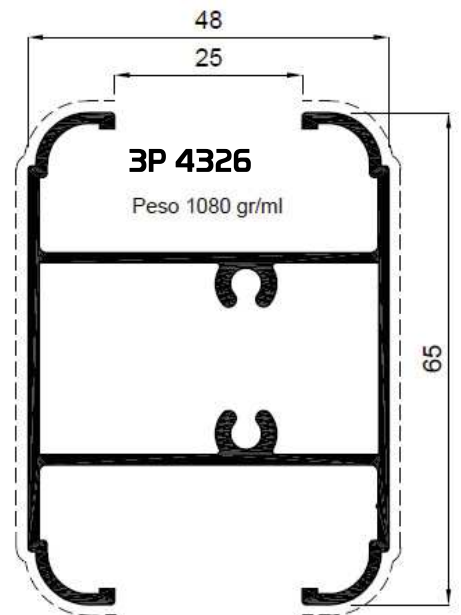
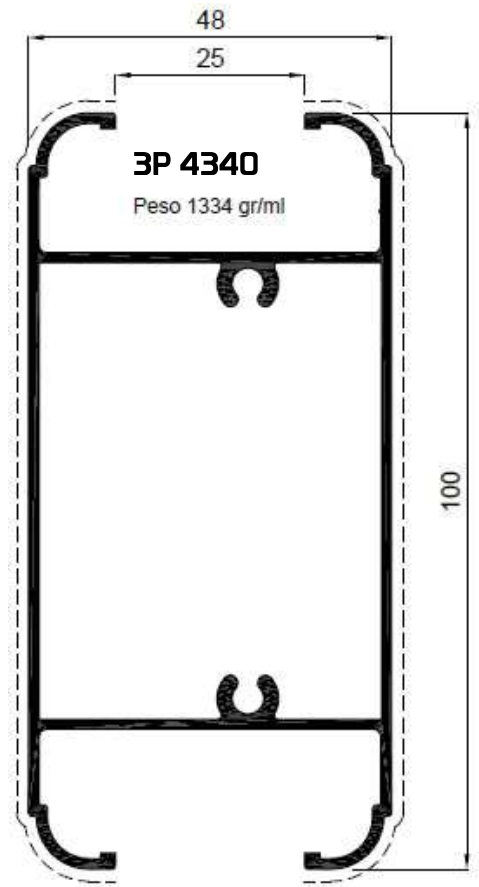
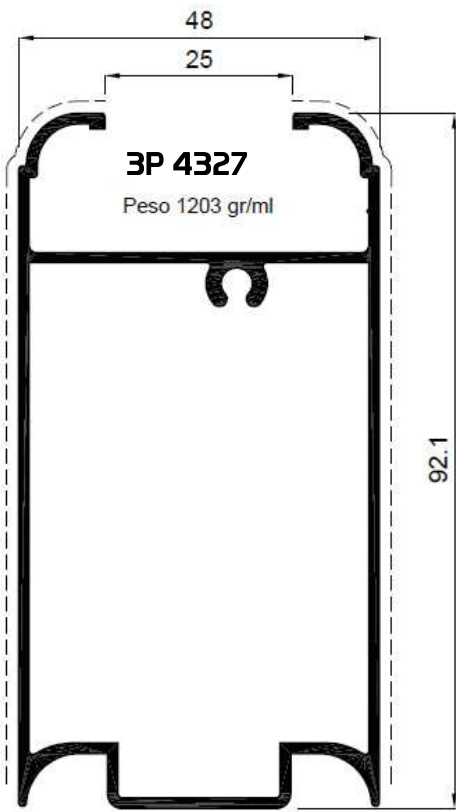

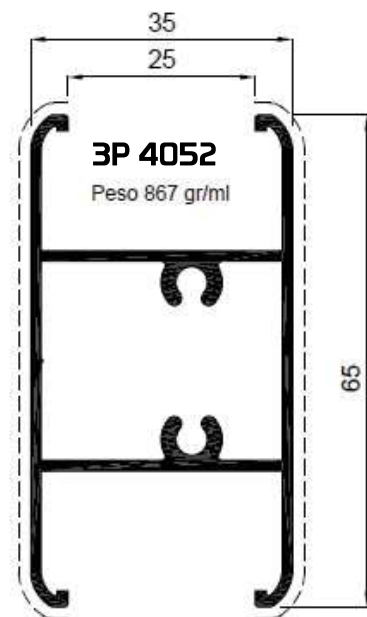
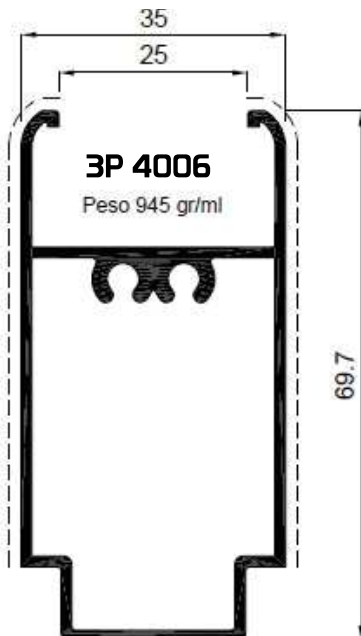
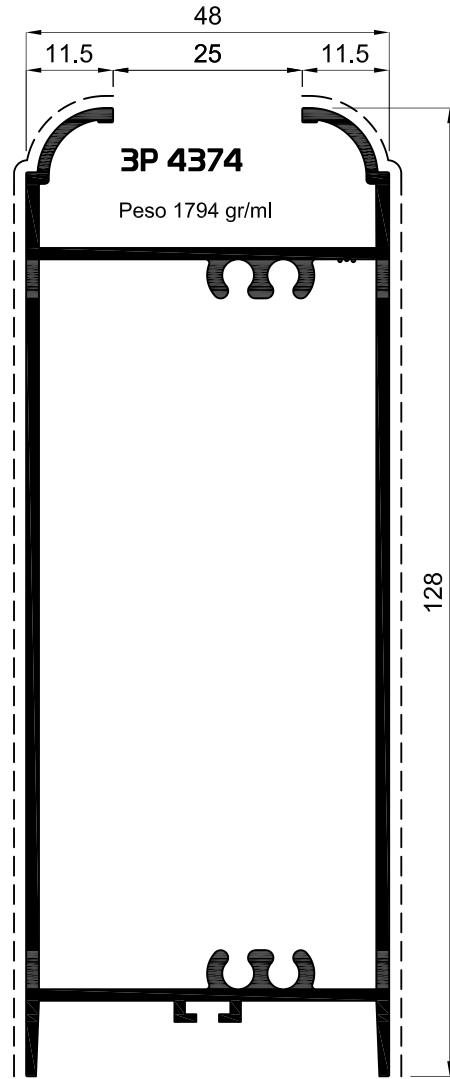
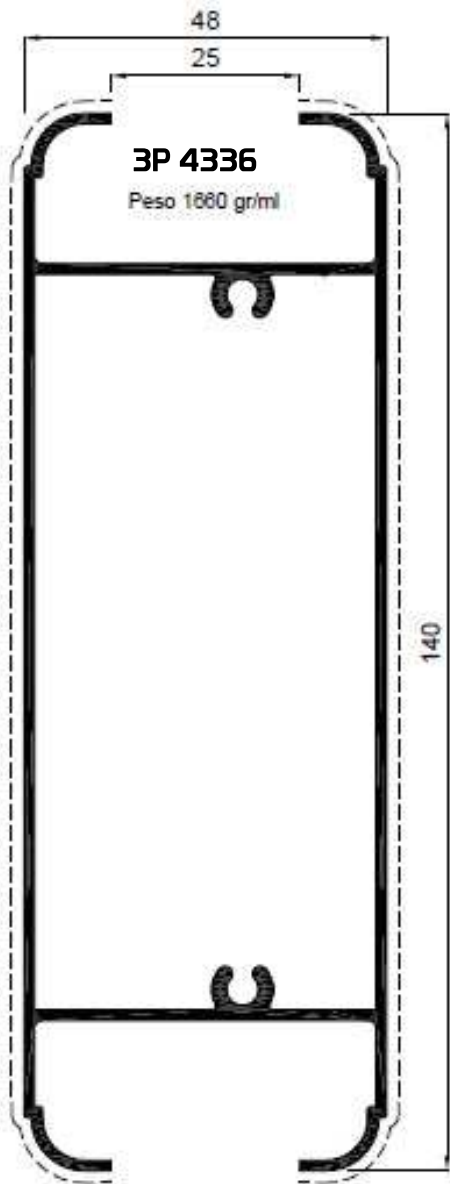



3P 43

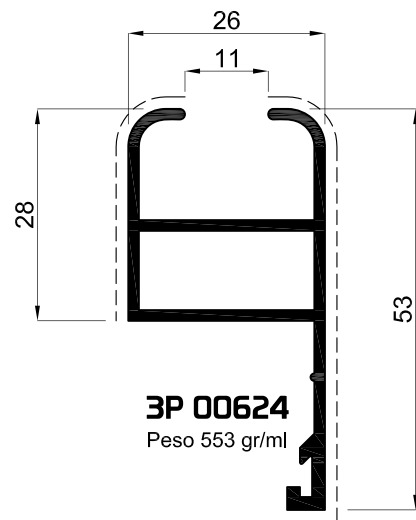
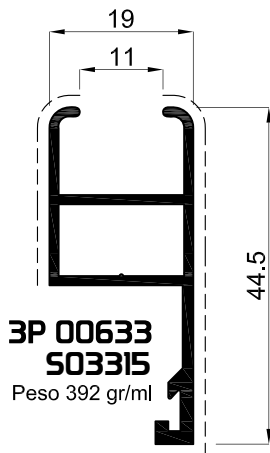
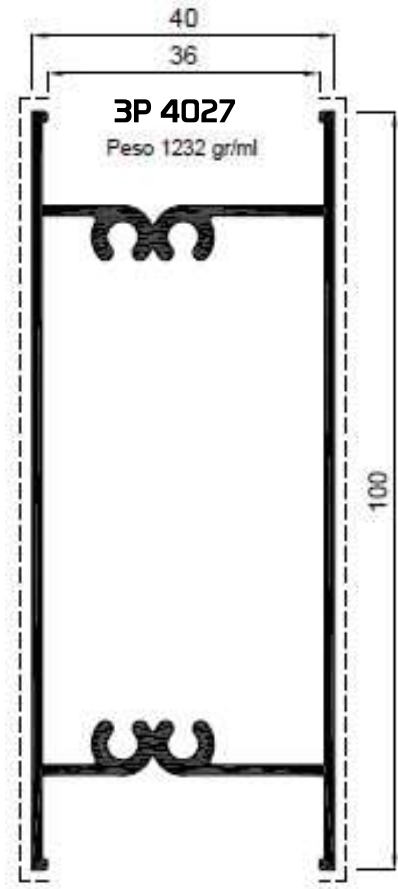
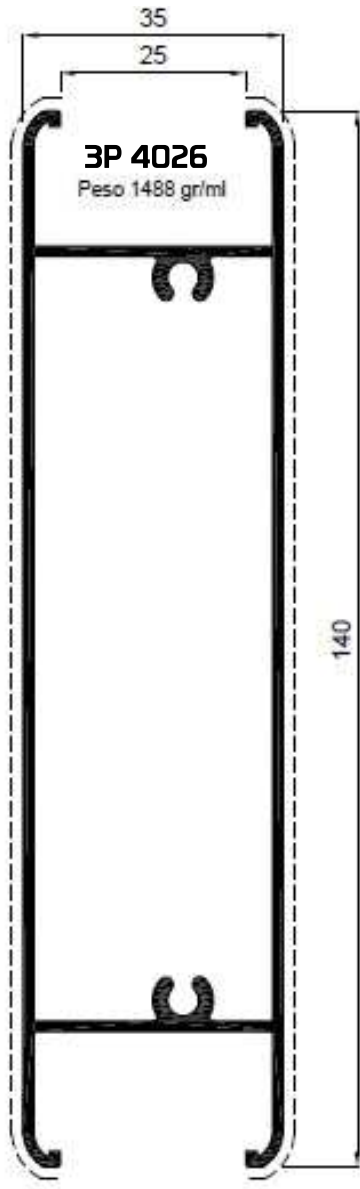

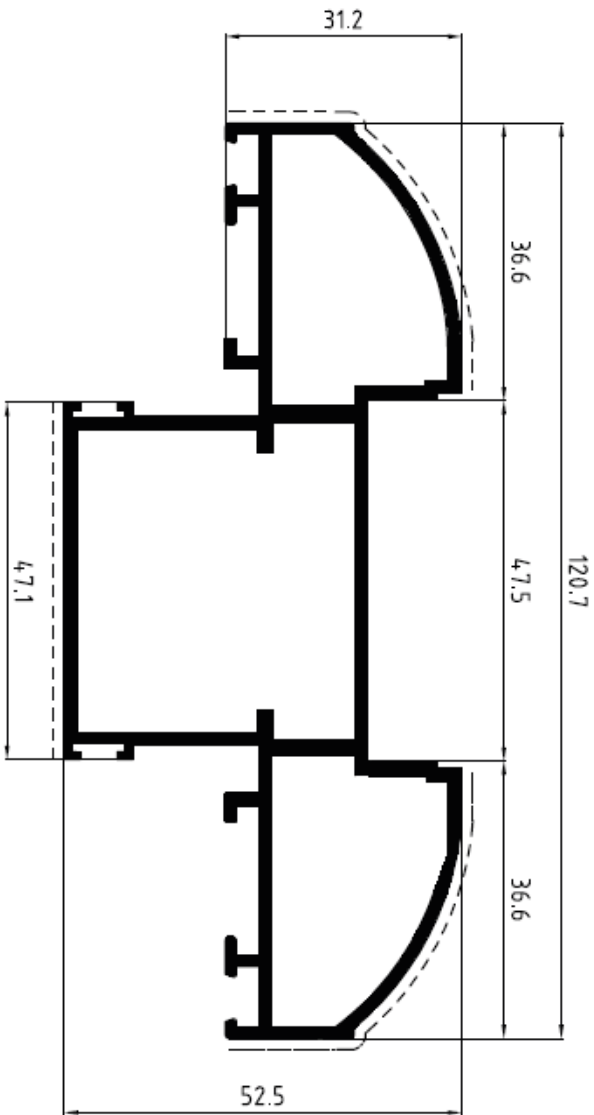

**3P 1506**

Peso 1737 gr/ml

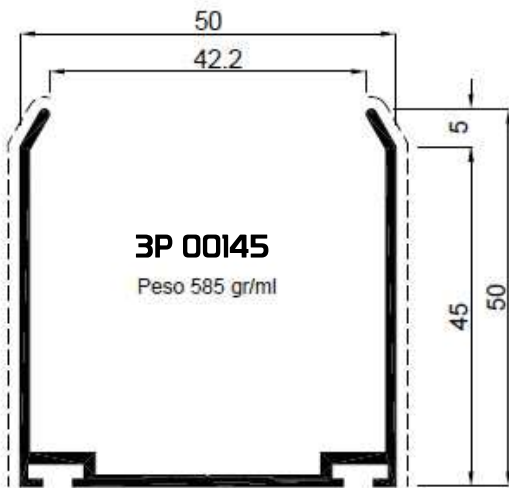

**3P 00145**

Peso 585 gr/ml

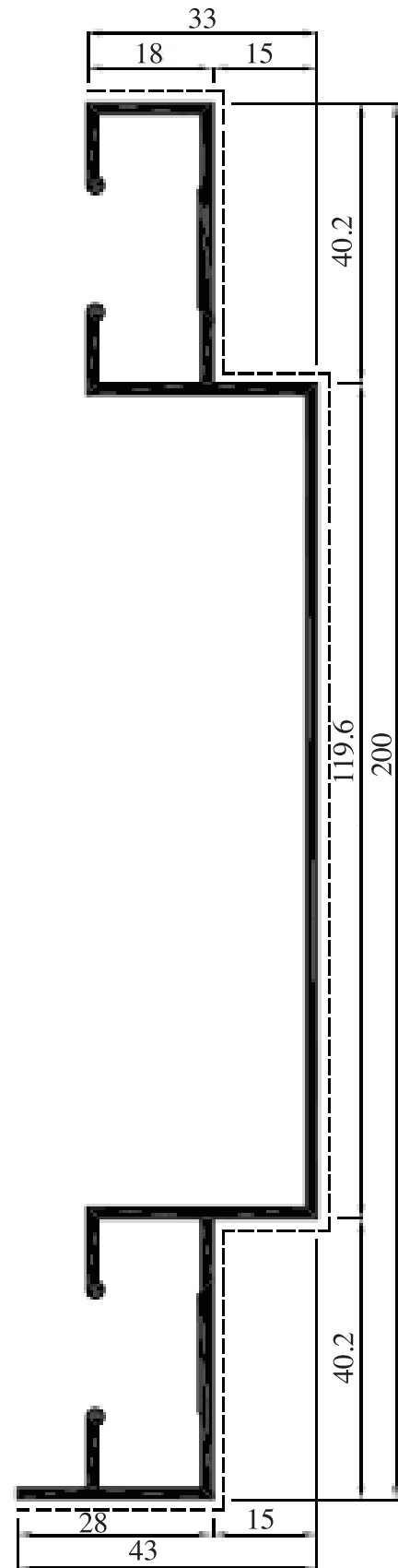

**3P 01153  
502382**

Peso 1583 gr/ml



3P 43

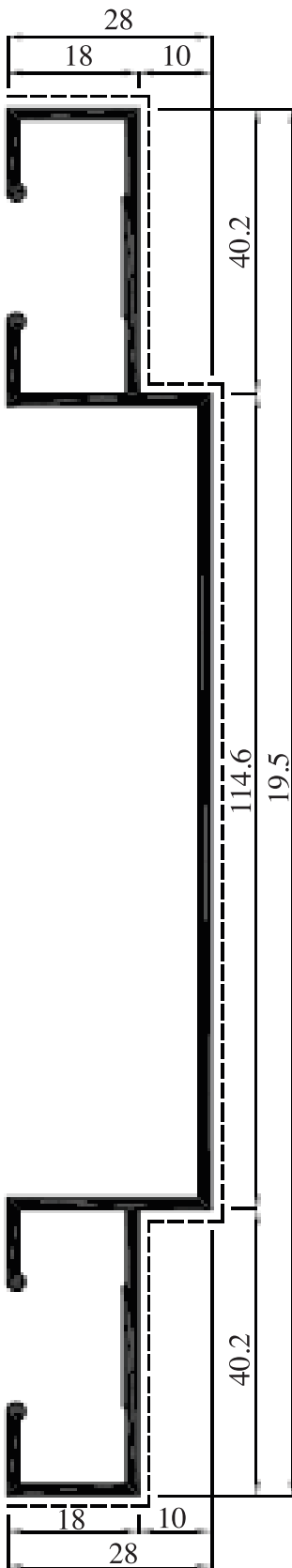

**201589**  
**BBC0299**

Peso 1455 gr/ml

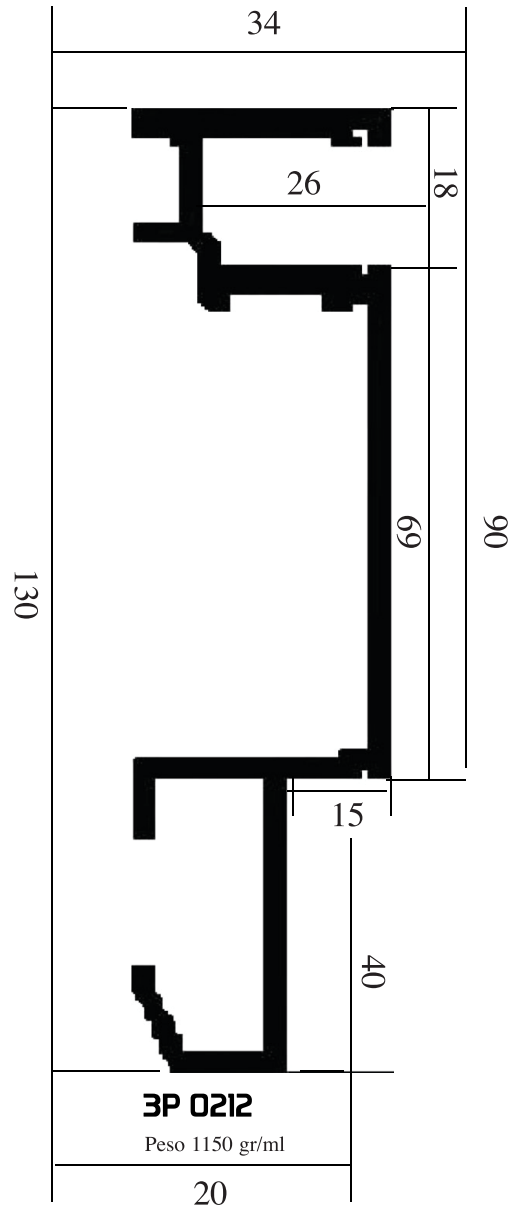

**3P 0212**

Peso 1150 gr/ml

20

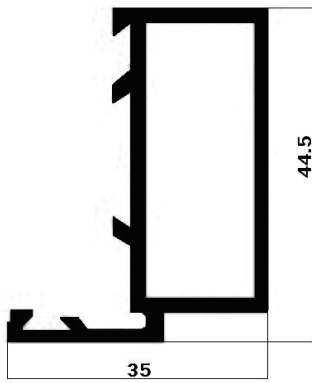

Peso 0.638 gr/ml  
**3P 40009**

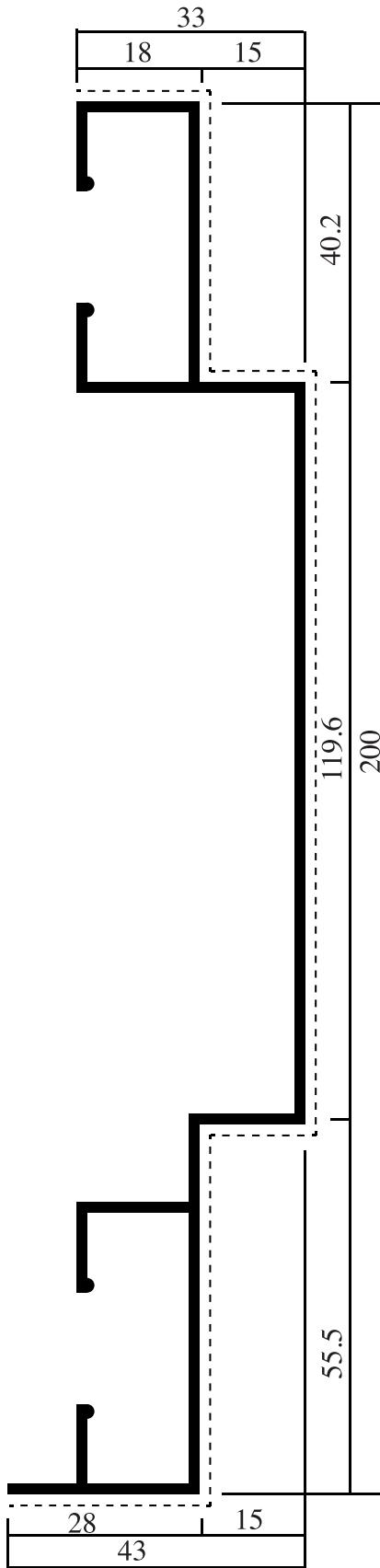

**217567**

Peso 1,682 gr/ml



3P 43

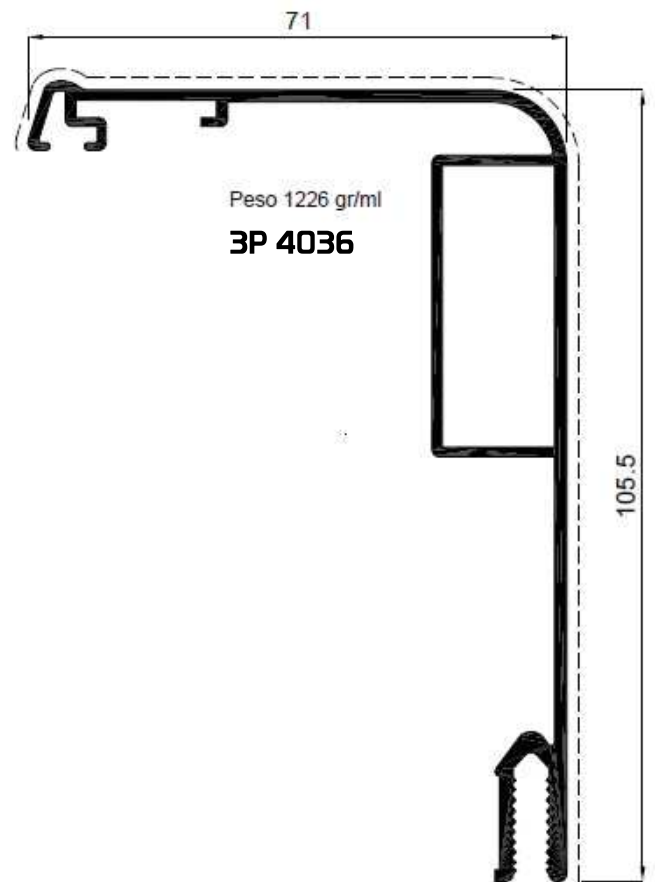
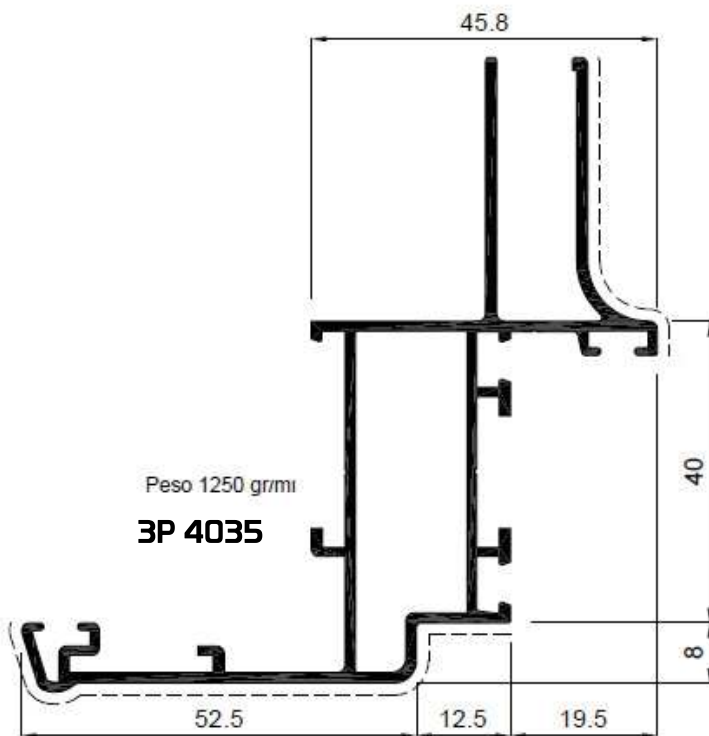
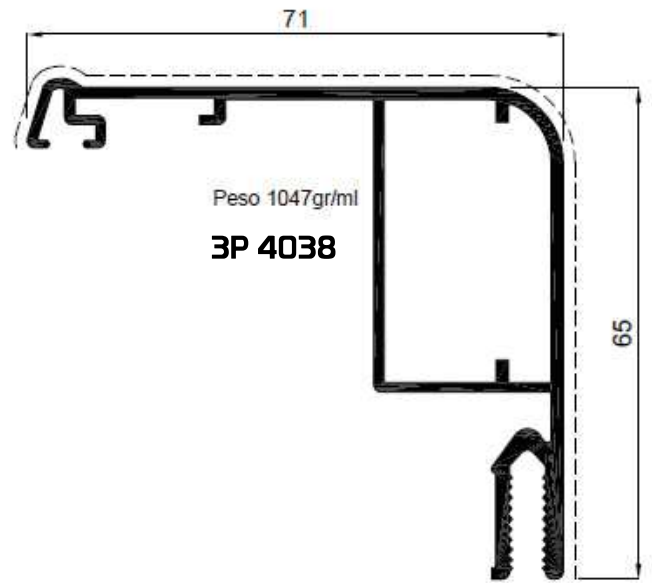
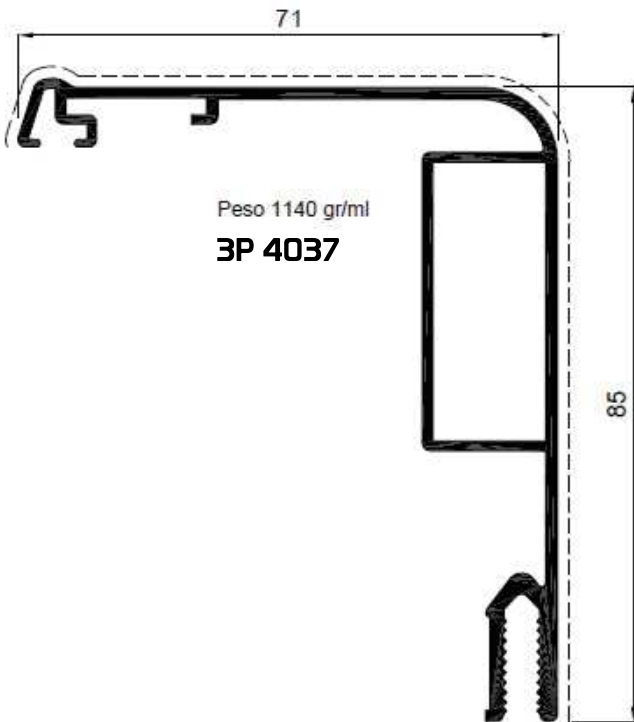



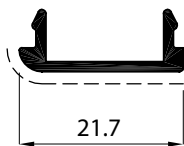
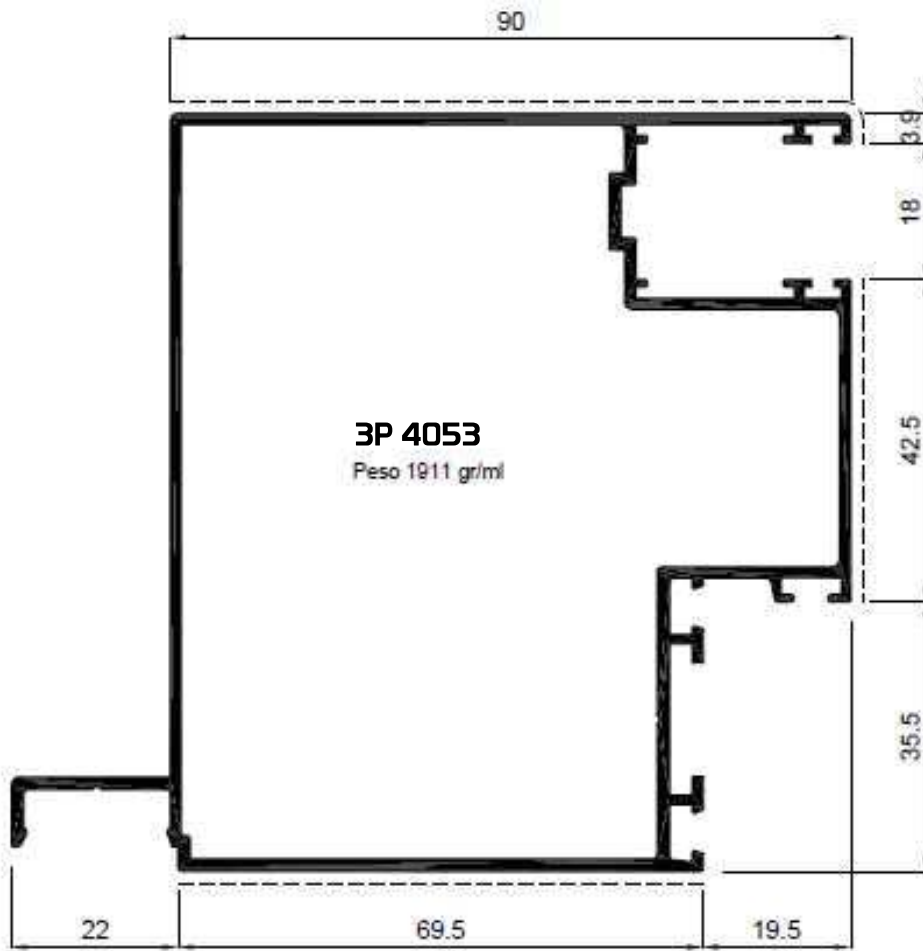

**3P4030**  
Peso 138 gr/ml



**3P 01990**  
Peso 495 gr/ml



3P 43

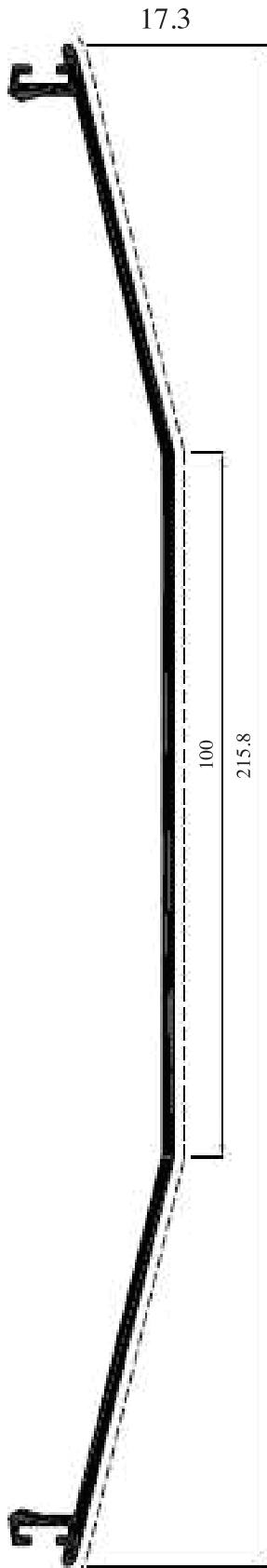

**3P 00646**  
Peso 1189 gr/ml

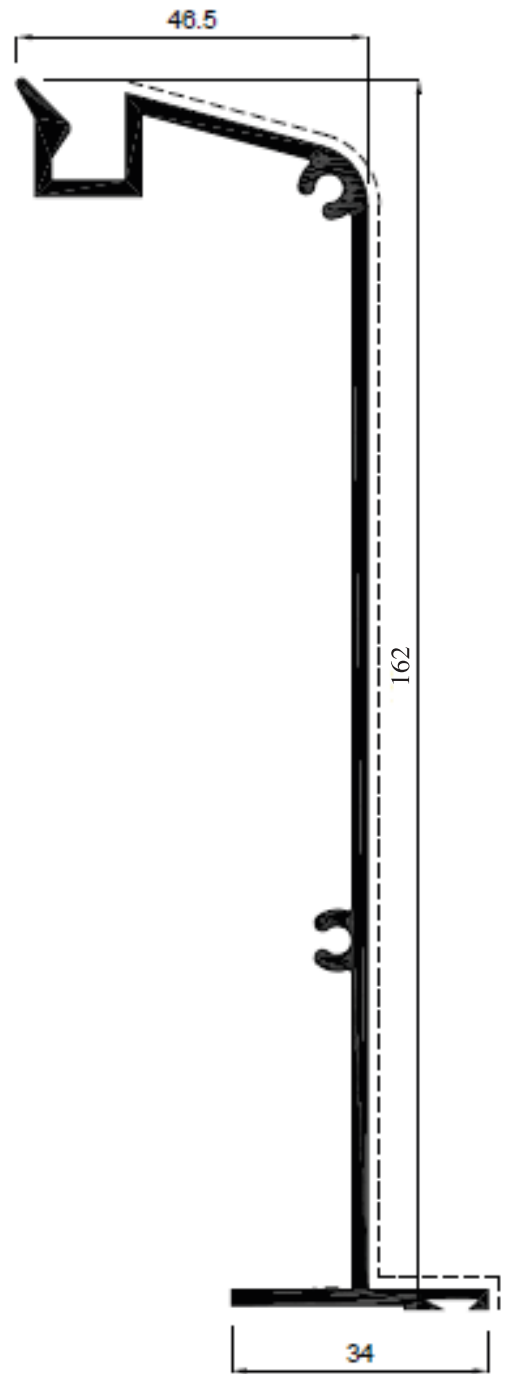

**3P 00630**  
Peso 1480 gr/ml

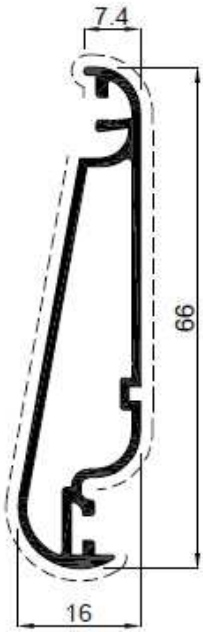

**3P 40032**  
Peso 497 gr/ml

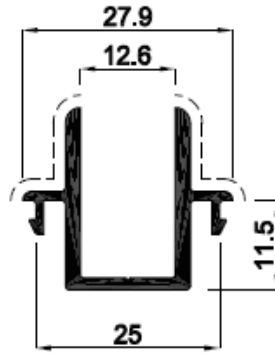

**3P 01067**  
Peso 370 gr/ml

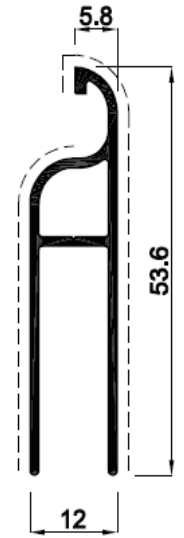

**3P 00540**  
Peso 380 gr/ml

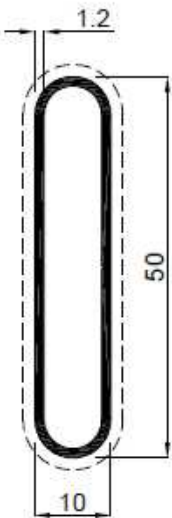

**3P 00086**  
Peso 350 gr/ml

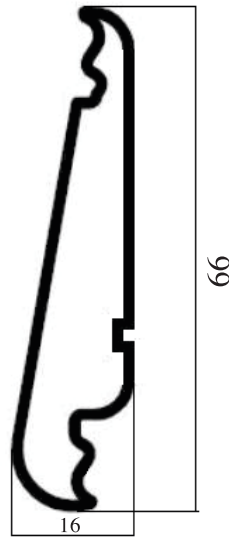

**3P 0029**  
Peso 424 gr/ml

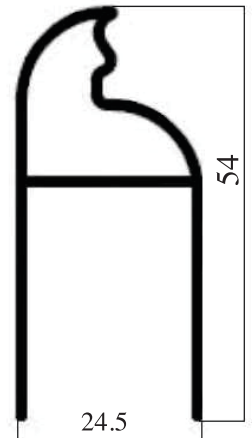

**3P 0048**  
Peso 409 mg/ml

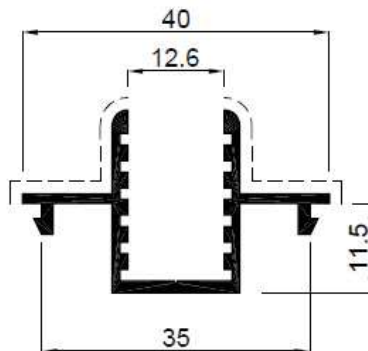

**3P 40019**  
Peso 365 gr/ml

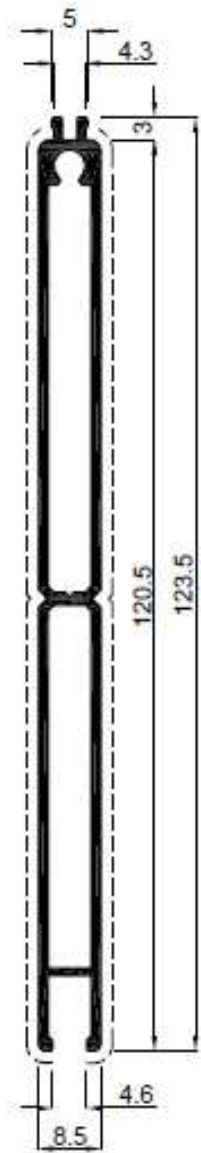

**3P 00563**  
**501990**  
Peso 960 gr/ml

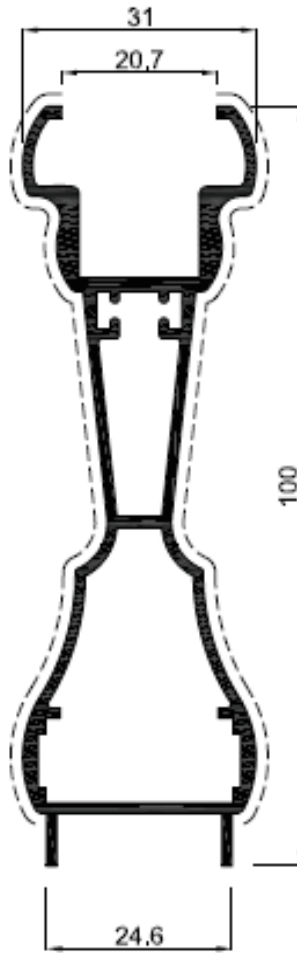

**3P 01678**  
Peso 1155 gr/ml

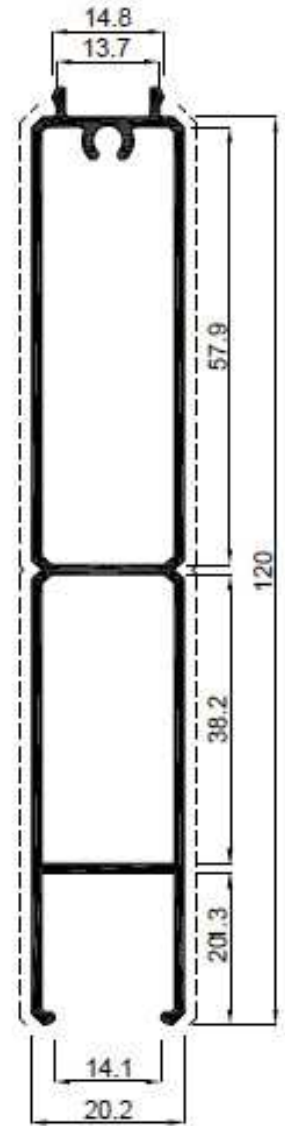

**3P 01065**  
**PE14459**  
Peso 1094 gr/ml

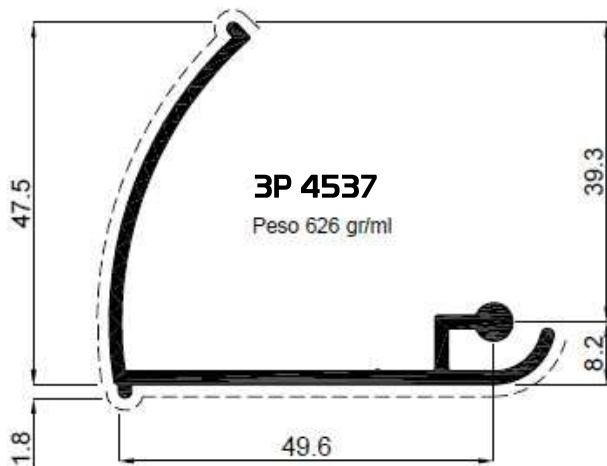

**3P 4537**  
Peso 626 gr/ml

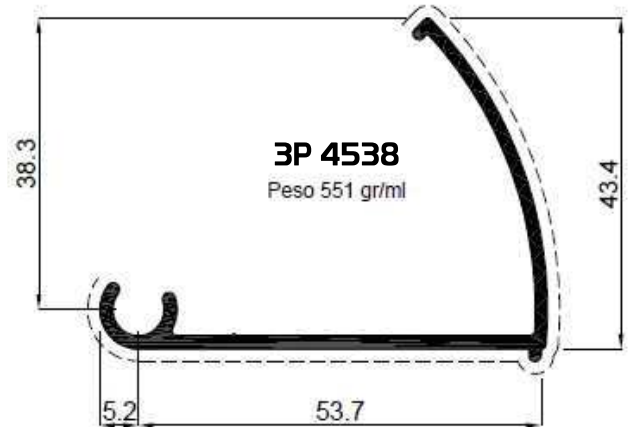

**3P 4538**  
Peso 551 gr/ml

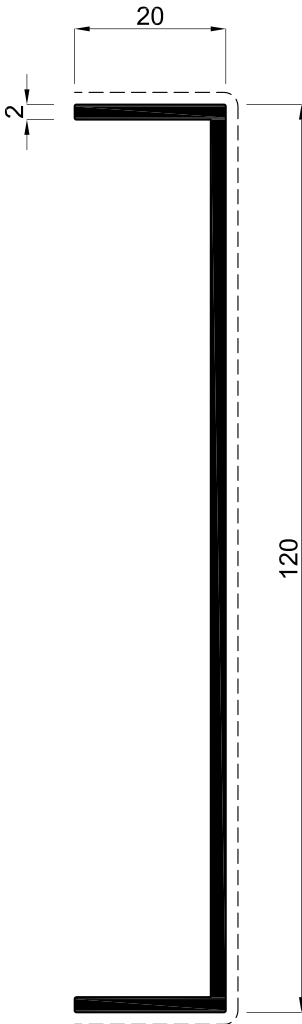

**BBC0042**  
**3P 3211**  
Peso 842 gr/ml

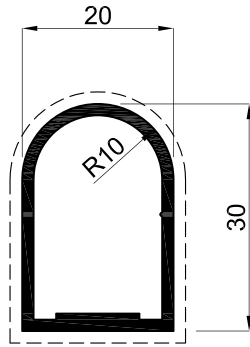

**3P 00637**  
Peso 372 gr/ml

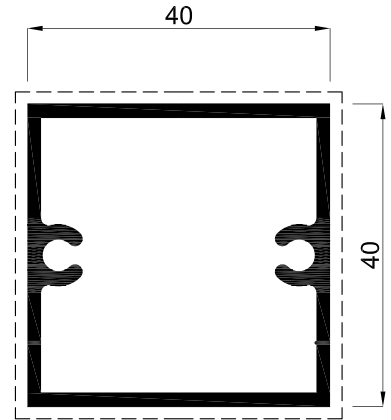

**3P 00628**  
Peso 876 gr/ml

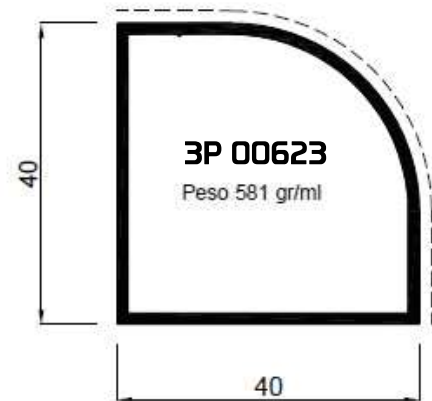

**3P 00623**  
Peso 581 gr/ml

- PROFILI RETTANGOLARI -



Art.	B mm.	H mm.	Sp. mm.	Peso gr/ml.
<b>3P 40052</b>	40	20	1,5	0,461
<b>3P 00702</b>	80	40	1,8	1131
<b>20x15x1</b>	20	15	1	0,219

- PROFILI A "L" -

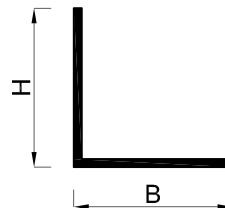

Art.	B mm.	H mm.	Sp. mm.	Peso gr/ml.
ET00693	20	20	1,5	0,156
ET00694	30	30	1,5	0,237
ET00695	40	40	1,5	0,318
ET00696	50	50	1,5	0,399